

Our Technology, Your Health.

JIANGSU BONSS
MEDICAL TECHNOLOGY CO., LTD.

MFG Factory 1: Building #7, No. 898, China Medical City Avenue,
Hailing District, Taizhou City, 225316 Jiangsu P.R. China.
MFG Factory 2: F6, Building G21, North of Xinyang Road, East of Koutai Road,
China Medical City Zone, Taizhou, Jiangsu 225316, China.
Tel: 0086-0523-86813258
Fax: 0086-0523-86813258
sales@plasma-surgical.com
sales@bonss.com.cn

www.plasma-surgical.com
www.BONSS.com.cn

Urology & Gynecology

MROHS / PKRP / PKRU

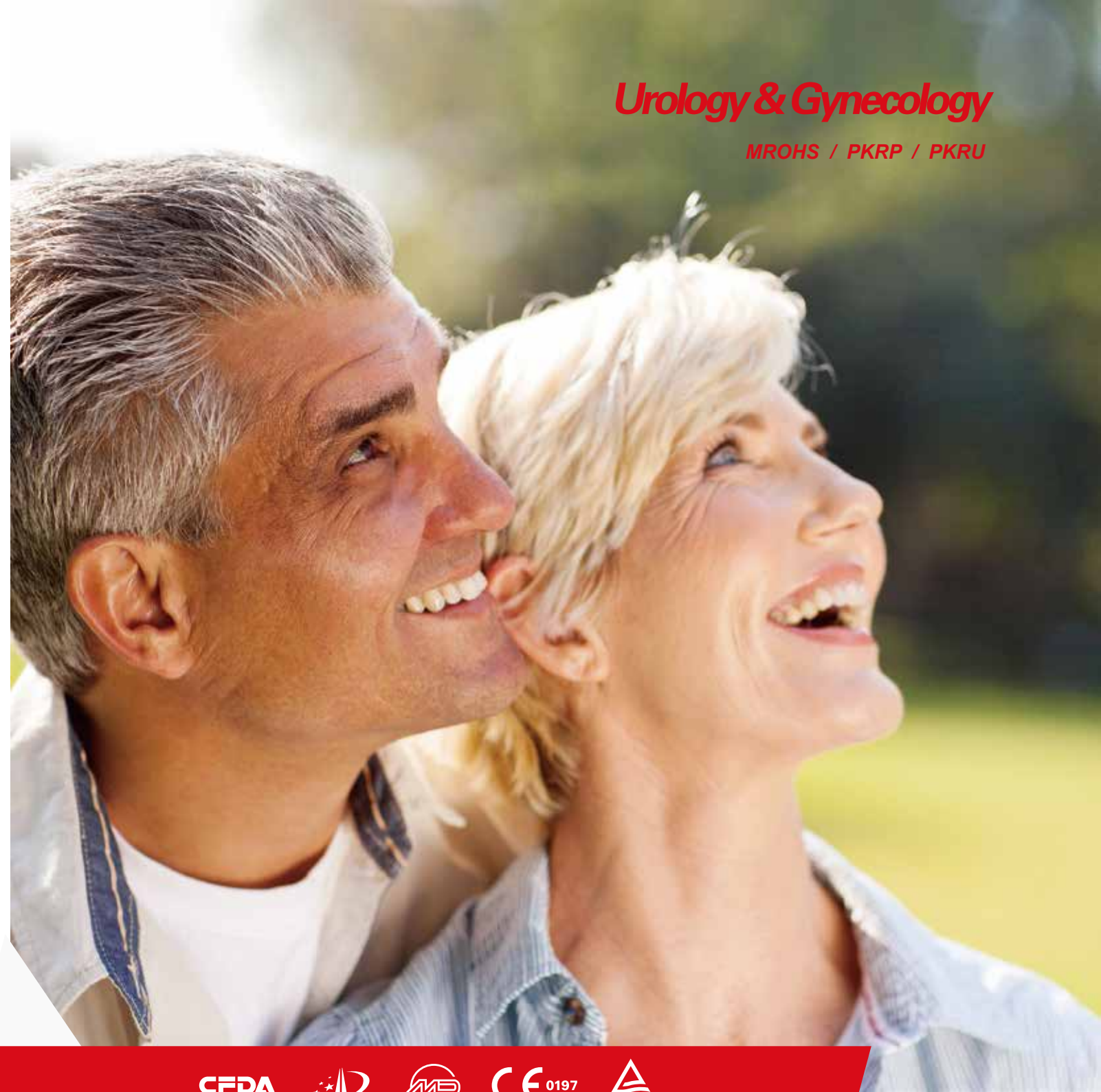

Information included herein is indicative only. Actual products you receive may differ.

CFDA



CE 0197



BONSS[®]
MEDICAL

MROHS

Minimally-invasive Resection Office Hysteroscopy System

OFFICE HYSTEROSCOPY



SEE & TREAT

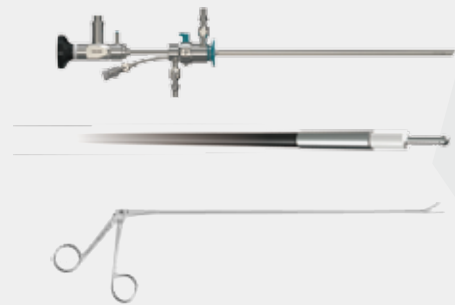

Office awake setting.

Reduce discomfort to patients.

No need for anesthesia and cervical dilation.

Reduce times of intervention and waiting lists.

Regulate the surgery without over/under treatment.

Safe and less complications, with wider clinical indications.

Make office hysteroscopy operations possible and reduce the costs.

Break through the limitations of cervical stenosis and avoid fragmented cutting of tissues.

- Work with conventional instruments for office hysteroscopy
- Liquid uterine distention medium
- Perfect combination of small-diameter operating hysteroscope and MIS plasma technology
- Break through the limitations of conventional hysteroscopy

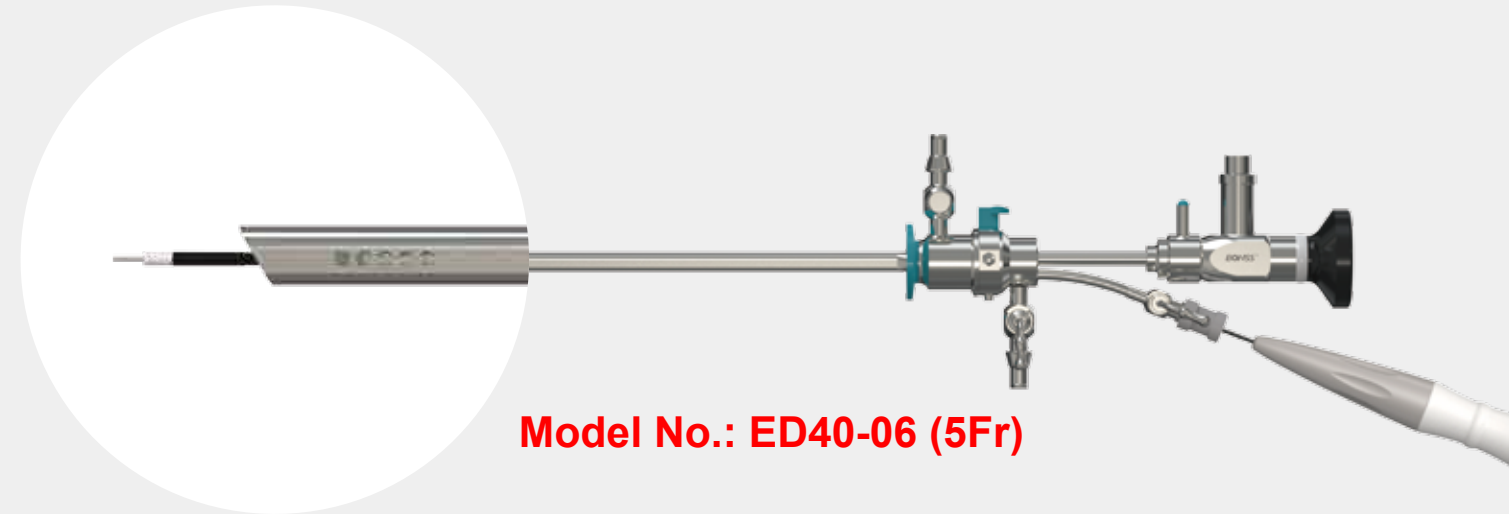

Model No.: ED40-06 (5Fr)

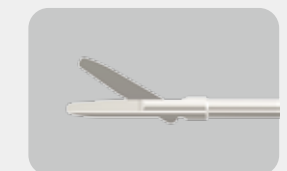
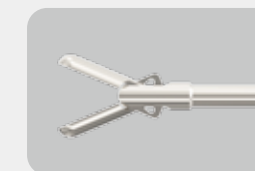
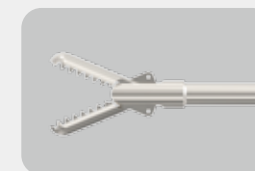

MROHS is a technique which one patient would introduce to another patient

MROHS Needle

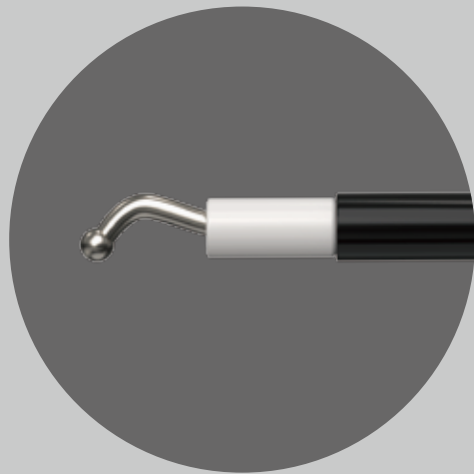

Special Design of Flexible and Bendable Structure

- 5Fr Ablation&Coagulation electrode, applicable for office hysteroscopy operations.
- Suitable for clinical applications of multiple anatomical sites and different pathologies in uterus cavity.

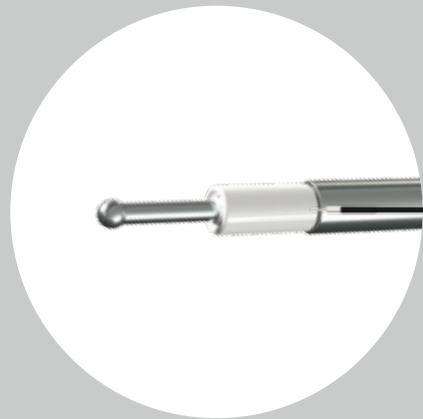

Patented Design

Special structure design to reduce bubbles

- 5Fr Ablation&Coagulation electrode for office hysteroscopy.
- Multiple designs of electrode tips to meet demands of different surgeries.
- Flexible and bendable electrode tip, applicable for different pathologies.
- Low-temperature plasma technology, with higher speed and efficiency to generate plasma energy, causes less bubbles and ensures a clearer surgical vision.
- Reduce the risk of embolism caused by bubble accumulation.
- Less blood loss, with excellent coagulation effect, adjustable power setting of coagulation.
- Precise cutting, with no carbonization, light adhesion and minimal damage to tissues.

Excellent coagulation effect

Ensure the optimized surgical safety and convenience



MROHS BiNe MC308

First option for tissue cutting, applicable for resection of uterine septum and endometrial polyps.



MROHS BiNeBD AC308

Flexible and bendable design, suitable for clinical applications of multiple anatomical sites and different pathologies in uterus cavity.



MROHS Spring BC308A

With better vaporization effect, the first option for uterine fibroids.

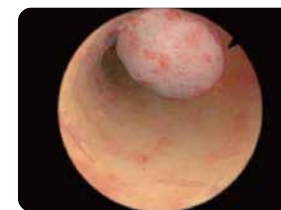
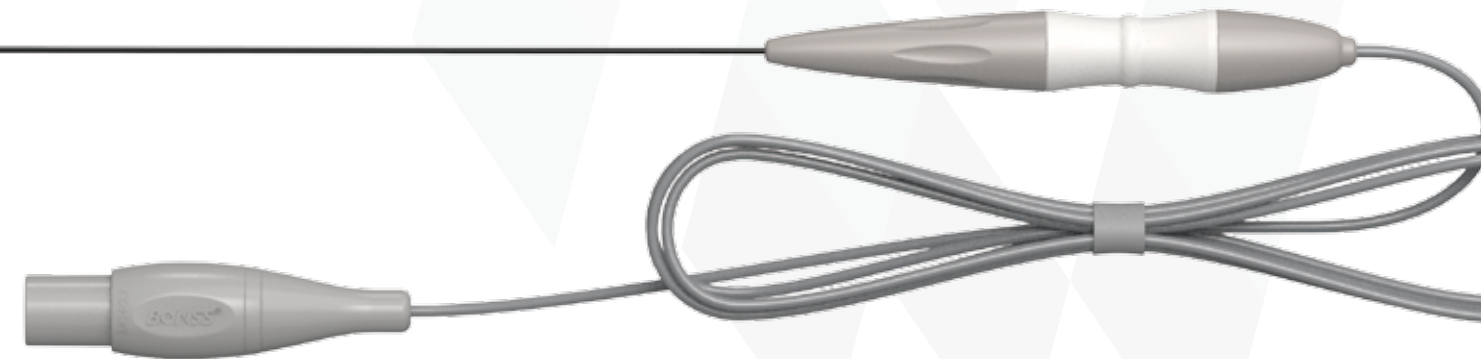

MROHS is a technique which one patient would introduce to another patient



Urology PKRP & Gynecology PKRU

Transurethral Plasma Kinetic Resection of the Prostate

Transcervical Plasma Kinetic Resection of the Uterus Pathologies

Bonss Radio Frequency Plasma Surgical System provides the transurethral plasma resection of the prostate and uterine cavity pathologies under normal saline solution with following advantages:

Low Working Temperature

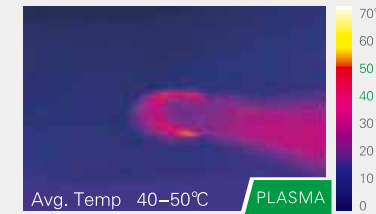

Less Thermal Damage

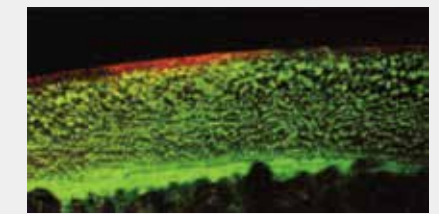
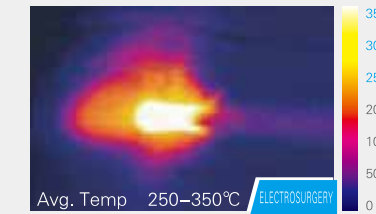

Temperature Contrast by Plasma and Electrosurgery

Reduced Thermal Damage

Plasma Surgery	Electrosurgery
Plasma Energy	Arc
Break Molecular Bonds	Cells Evaporation
40–50°C	250–350°C
0.9% Normal Saline Solution	5% Mannitol
Multipolar/Bipolar, No Patient Plate	Monopolar, Requires Patient Plate
Reduced Thermal Damage	High Thermal Damage
No Carbonization	Carbonization

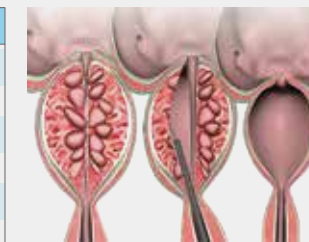

Urology PKRP



Gynecology PKRU

Minimally-Invasive Surgery

The Minimally-Invasive Solution at Your Hand

No Risk of TURP Syndrome (Water Intoxication)

By the bipolar radio frequency plasma surgery under normal saline solution, there is no risk of TURP Syndrome (Water Intoxication), which is a normal post-operative syndrome by TURP(Transurethral Resection of Prostate by traditional electrosurgery).

Safe Operation

The features of low working temperature and low thermal damage provide protection of erectile nerves. Thanks to the bipolar technology, the electricity does not flow through human body or the working element, to ensure the safety of both patients and surgeons. The bipolar plasma energy circuit is generated at the electrode tip, which reduces the Irritation of the obturator nerve. No need to seal the nerves or use the muscle relaxant. It can support the enucleation, to provide the protection of urethral sphincter.

Convenient Operation

In one versatile single-use plasma electrode, it provides resection, ablation, coagulation and hemostasis capabilities for simple surgical process. The effective resection and ablation capabilities shorten the operation time and reduce the surgeon's workload.

Precise Operation

The precise resection and ablation have no injury on the capsule, which is very important for TUR-BT (BladderTumor), and also greatly lower the risk of the uterine perforation.

Fast Recovery

The feature of low working temperature, reduced thermal damage, and the pseudomembrane generated after resection and ablation, ensures a fast recovery.

Reduced Complications

Reduced post-operative urethral thermal injury, sphincter injury and stenosis.
Reduced post-operative urinary tract infection and irritation.
Reduced post-operative bladder irritation, transient urinary incontinence, erectile dysfunction and more.

Integrated Multifunction

In one versatile radio frequency plasma surgical system, it provides bipolar capability, for urology and gynecology applications.

Less Blood Loss



Urology PKRP

Gynecology PKRU

Reduced Thermal Damage, Fast Recovery

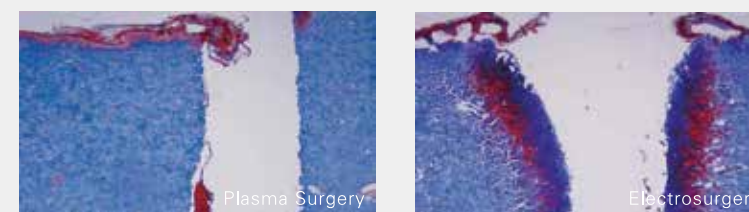

Injury Contrast by Plasma Surgery and Electrosurgery

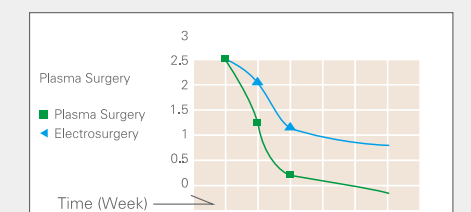

Post-op Inflammatory Response by Plasma and Electrosurgery

Shortened Hospital Stay Time

The hospital stay for patients treated by plasma technology can be shortened by 2–4 days, compared to that by conventional surgical methods.

PKRP&PKRU

BPH
Bladder Tumor
Myomas/Polyps/Adhesions/Septa
Endometrial Ablation

Model No. : ED30-40

Model No. : ED30-29

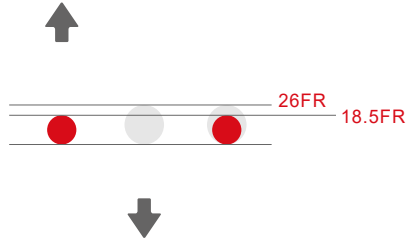

LoopXS AC307

Can produce larger tissue fragments with fewer cuts and faster speeds.

Suitable for large prostate resection, bladder tumor, urethral stricture, myomectomy, endometrial polyp, residual embryonic tissue after abortion, and cyst surgery.



LoopXL AC307A

The wider electrode loop can provide more effective Coagulation than a conventional electric loop during cutting. Suitable for large prostate resection, bladder tumor, urethral stricture, myomectomy, endometrial polyp, residual embryonic tissue after abortion, and cyst surgery.



VapButton MC307C

Applicable to cystic ablation, enucleation, large-area tissue vaporization and coagulation.



Hook

Applicable to narrowing of the lumen, dissection of the cyst, and slitting surgery.



Roller

Applicable to cystic ablation, large-area tissue vaporization and coagulation.



VapBall

Applicable to cystic ablation, large-area tissue vaporization and coagulation.



ShovelLoop

Applicable to prostate resection, bladder tumor, urethral stricture, cyst ablation, large area tissue vaporization and coagulation.



HysNeedle

The Needle design for ablation, cutting and coagulation. Minimal bubbles while operating, for optimized surgical view. Bendable tip, suitable for different pathology locations.

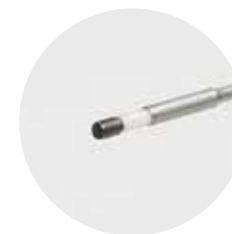

Spring

The spring design for ablation, coagulation and vaporization. Minimal bubbles while operating, for optimized surgical view.

ARS800 Radio Frequency Plasma Surgical System



How does it work

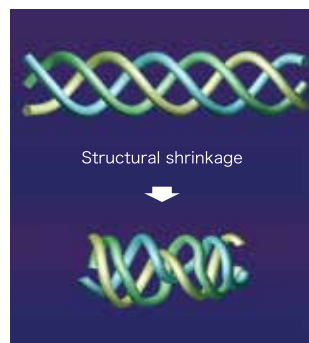

ABLATE

The Radio Frequency energy flows through the active electrode and return electrode, and by the conductive saline solution, it generates precisely focused plasma sheath around the electrodes. The plasma sheath consists of massive charged particles which can generate sufficient energy of strong oxidizing when accelerated by the electric field. The generated energy is powerful enough to break the organic molecular bonds within the tissue, and make the tissue rapidly dissolved into molecular and atoms level at a relatively low temperature of 40-70 C. The device provides rapid and efficient ablation and resection capabilities of soft tissues in relatively low temperatures.

Radio Frequency & Plasma Effects

The serious blood loss during procedure blocks the surgical visions and causes high potential risk, which would increase the difficulties and time of the surgical procedures. One of the solutions is BONSS Radio Frequency Plasma Surgical System. The double effects of Radio Frequency and Plasma have the advantage as below.

- The blood vessels or the bleeding points are coagulated before resection, thus less blood loss during procedure is achieved.
- The blood vessels are sealed during surgical procedure, to ensure the ablation and resection process with less blood loss, and to ensure a clear surgical field.
- In one versatile single-use plasma electrode, it provides resection, ablation, coagulation and hemostasis capabilities for simple surgical process.

Excellent Performance



Radio Frequency Plasma Technology

It uses the low frequency of 100khz. Compared with the technology of higher frequency over 200khz, the Low-frequency Plasma Technology provides more precise resection and ablation, and lower working temperature.

Features: Lower working temperature, Reduced thermal damage, No edema period, Short hospital stay. Precise resection, and ablation by RF Plasma energy, Similar operation and effect to laser enucleation.

Systematic Working Mode

Two working modes:

ABLATE for resection and ablation at Yellow control panel and Yellow foot pedal.
COAG for coagulation and hemostasis at Blue control panel and Blue foot pedal.

Intelligent Control System

Designed with automatic identification of electrodes, foot switch and power supply, which are displayed respectively on the device control panel, and automatic default power output value for different electrodes designs.

Endoscopic ABLATION and COAGULATION Functions

Bonss ARS Radio Frequency Plasma Surgical System can support endoscopic resection, ablation, coagulation and hemostasis, such as resectoscope. Product safety has been approved by the health authority to meet the standard of endoscopic surgery. The features include accurate and precise endoscopic resection, no risk of obturator neural reflex, no risk of post-TURP edema.

Automatic Protection

The electrical circuit system can constantly monitor power output and automatically suspend power output when there is an instantaneous peak current. For example, it will automatically suspend radio frequency output when electrode contacts metal, and automatically resumes work after the electrode has returned to the proper distance.

Foot Switch

The water-proof, pressure-resistant, and convenient foot switch have two working modes of ABLATE and COAG, each identified in different colors and working sounds.

The ABLATION power setting level can be adjusted on the foot switch.



Integrated Function

In one versatile single-use electrode, it provides ABLATE for resection and ablation. Coag for coagulation and hemostasis capabilities. The integrated electrode enhances surgical vision, controlled resection for rapid removal of soft tissues.